

Shape Design and Styling solutions



CATIA V5

CATIA® V5 is the leading product development solution for all manufacturing organizations, from OEMs, through their supply chains, to small independent producers. The range of its capabilities allows CATIA V5 to be applied in a wide variety of industries, such as aerospace, automotive, industrial machinery, electrical, electronics, shipbuilding, plant design, and consumer goods, including design for such diverse products as jewellery and clothing.

CATIA V5 is the only solution capable of addressing the complete product development process, from product concept specifications through product-in-service, in a fully integrated and associative manner. It facilitates true collaborative engineering across the multi-disciplinary extended enterprise, including:

- *Style and form design*
- *Mechanical design and equipment and systems engineering*
- *Managing digital mock-up*
- *Machining*
- *Analysis*
- *Simulation.*

CATIA products are based on the open, scalable V5 architecture.

By enabling enterprises to reuse product design knowledge and accelerate development cycles, CATIA helps companies speed-up their responses to market needs and frees end-users to focus on creativity and innovation.



Shape Design and Styling solutions

CATIA – Shape Design and Styling solution set delivers innovative and fun-to-use products for the creation, control and modification of engineered and freeform surfaces.

Its highlights include:

- **The most complete and integrated portfolio for the creation of advanced shapes** – The user can create shapes based on a physical mock-up or styled sketches by virtue of the Reverse Engineering solution. It covers design processes for preliminary to detailed parts, which require consequent surfacing with Mechanical Shape products. It also describes mechanical shape assemblies with Automotive Body-In-White Fastening, such as body panels and crafts harmonious aesthetic shapes with the Freestyle product set. Generate high quality photo-realistic views and dynamic renderings in real time with visualisation tools.
- **General to specialised requirements for all industry segments are catered for** – A complete P1 platform delivers high levels of productivity and efficiency to all manufacturing industries. High range technologies enable powerful and process-centric skills.
- **Surface design made accessible to everyone** – These particularly easy-to-use tools for surfaces and shapes are for parts designed by non-surface specialists or advanced shape designers looking for a complete surfacing tool set.
- **The most flexible modification schemes** – Change management is built into the solution's design, providing the user with shorter conceptual testing times. The associativity with other CATIA V5 domains also allows for an efficient model for manufacturing management.
- **Harnessing the power of knowledge-driven shapes** – These solutions capture design intent as the design is built with a combination of interactive shape design and styling functions along with the solution paradigm of embedded knowledge. This provides the power of explicit rules that define product behaviour. As a result, these solutions act as an expert advisor to guide users through tasks, warning them of rule violations and conflicts to achieve automated design generation and reduced risk.

Configurations



CATIA – Styled Mechanical Design 1 (YM1)

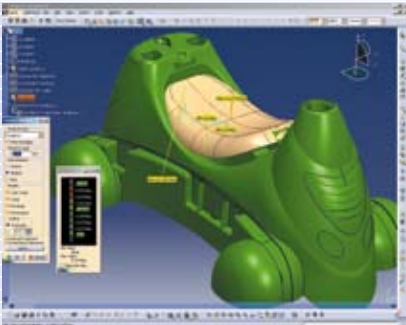

CATIA – Freestyle Shaper 2 (FS2)

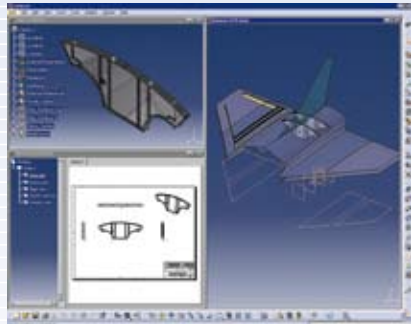

CATIA – Hybrid Design 2 (HD2)

CATIA – Styled Mechanical Design 1 (YM1)

Provides a 3D product creation package that is perfectly suited to the consumer goods domain. This includes comprehensive part and assembly design features, as well as associative drawing extraction capabilities and advanced surface creation tools. Designers will also find that it has all the 2D drafting features necessary for efficient drawing production.

This configuration is greatly empowered by the comprehensive package of core Shape and Styling solutions, designed to meet the industrial-scale needs of the consumer goods domain. In addition, the import and export of IGES and STEP data make collaborative design throughout the extended enterprise very easy. Users managing parts from external applications will appreciate the CATIA – Healing Assistant 1 (HA1) product, which allows them to check validity of imported geometry with regard to CATIA V5 modelling criteria. It can also be used to improve the topology and geometry of analysed objects.

CATIA – Freestyle Shaper 2 (FS2)

Provides all of the necessary tools to address intuitive, dynamic surface sculpting and real-time diagnosis requirements, as well as the production of associative drawings. In addition, it offers integration tools that are compatible with CATIA V4. Customers benefit from a seat definition that can be seamlessly upgraded by adding dynamic multi-surface deformation and real-time diagnosis functions.

CATIA – Hybrid Design 2 (HD2)

Provides in one seat all the necessary tools to perform advanced 3D design of mechanical parts, assemblies and complex shapes in the context of the full scale digital mock-up, and generation of production drawings.

As a CATIA P2 configuration, HD2 offers advanced 3D orientation features, such as fly-through navigation and advanced specification graph display and manipulation. Customers benefit from its built-in interoperability with other CATIA V5 solution sets. It is the configuration of choice for existing CATIA V4 customers because it offers integration tools that are compatible with V4 and data interfaces to the most frequently used industry standards. Customers also benefit from a seat definition that can be seamlessly upgraded by the addition of shape design capabilities, allowing for the design of more complex parts using hybrid-modelling methodologies.

CATIA – Reverse Engineering 2 (RE2)

Provides all of the necessary tools to cover the complete surface reverse engineering process. From the import of digitised data, including clean up and tessellation, to the recovering and finishing of surfaces, RE2 allows the user to quickly visualise design study alternatives.

RE2 provides the best technology available for managing potentially huge meshes and faithfully recovering shapes with high quality results. The RE2 set of easy-to-use capabilities allows manufacturing companies to, not only shorten the design validation phase, but also to enhance the quality of CAD data in the preliminary design process.

CATIA – Freestyle Optimizer 2 (SO2)

Provides all of the necessary tools to address the advanced surface sculpting and real-time diagnostic requirements for automotive or Class-A parts, as well as the production of associative drawings. In addition, it offers integration tools that are compatible with CATIA V4. Customers benefit from a seat that can be seamlessly upgraded by adding dynamic multi-surface deformation and real-time diagnosis functions to its definition.

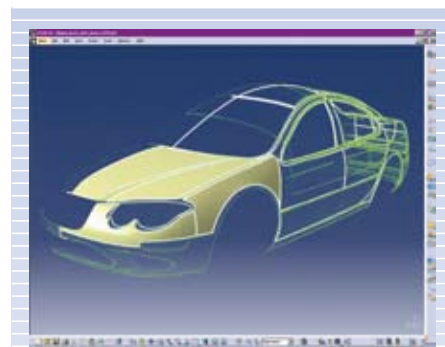

CATIA – Reverse Engineering 2 (RE2)

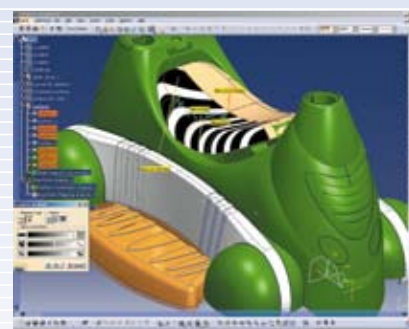

CATIA – Freestyle Optimizer 2 (SO2)

Configurations

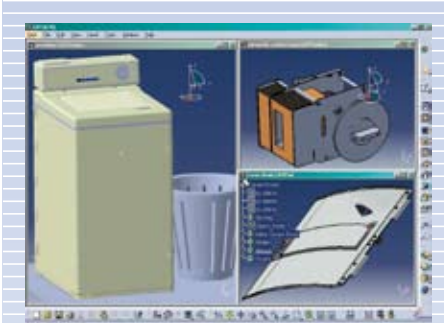

CATIA – Styled Mechanical Design 2 (YM2)

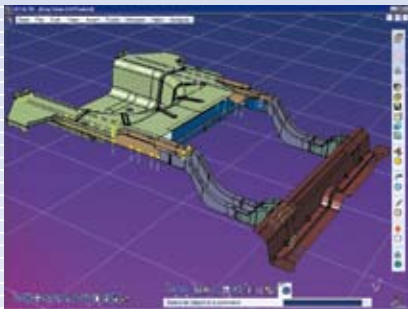

CATIA – Automotive Body-In-White Design 3 (AB3)

CATIA – Styled Mechanical Design 2 (YM2)

Provides a 3D product creation package that is perfectly suited to the Consumer Goods domain. This includes comprehensive part and assembly design features, as well as associative drawing extraction capabilities and advanced surface creation tools. Designers will also find that it has all the 2D drafting features necessary for efficient drawing production.

This configuration is greatly empowered by the comprehensive package of core Shape and Styling solutions, designed to meet the industrial-scale needs of the Consumer Goods domain. In addition, the import and export of IGES and STEP data, as well as the ability to work in a hybrid CATIA V4/V5 environment, make collaborative design throughout the extended enterprise very easy.

Basic knowledge capabilities provided through Knowledge Expert will allow designers to import and use corporate knowledge stored in rule databases to ensure the consistency and quality of their designs. Users managing parts from external applications, such as mold makers, will appreciate the Healing Assistant product, which allows them to check validity of imported geometry with regard to CATIA V5 modelling criteria. It can also be used to improve the topology and geometry of analysed objects.

CATIA – Automotive Body-In-White Design 3 (AB3)

Provides all the necessary tools to perform advanced and specific 3D design of Body-In-White elements used in the automotive industry in one seat. It provides the user with a full portfolio of productive and innovative design and drafting solutions, including applications concerning shape design, image rendering and interfaces. It also gives the user an end-to-end solution to address the complex design of productive Body-In-White parts, and achieves ready-to-manufacture digital mock-ups that benefit from the advanced knowledge of CATIA V5 and its integration with CATIA V4.

Using CATIA – Automotive Body-in-White Fastening 3 (ABF) provides the user with intuitive tools to create and manage spot-like fasteners. The user can switch from a 3D point-shape definition to a 3D hemispherical-shape specification if needed. In addition to placing the fasteners, reports can be issued from the application in order to list fastener location coordinates and the properties of joined parts. The framework of this solution relies on the P3 platform providing overwhelming Product and Process integration expertise, with processes focused on automotive Body-In-White fastening.



Products

Styling

CATIA – Digitised Shape Editor 2 (DSE)

Addresses digitalised data import, clean up, tessellation, cross sections, character line, shape and quality checking with real time diagnosis. This product takes place at the beginning of the Reverse Engineering cycle, just after the digitising machines and before several processes covered thanks to the complementary use of other CATIA V5 applications from mechanical and freestyle surfaces design to direct manufacturing. The inspection process can be directly handled with DSE by utilising alignment between Clouds of points and CAD models.

CATIA – Shape Sculptor 2 (DSS)

Provides modelling tools to quickly create, edit, or enhance a shape from a concept or an existing physical model. This new approach of creating aesthetic and conceptual forms allows non-CAD specialists to manipulate and test 3D virtual models. The objective is to enhance the collaboration between design and engineering offices through a fun and easy to use sculpting tool. In this way, Shape Sculptor complements and reinforces the existing CATIA surfacing tools, such as CATIA – Freestyle Shaper 2 (FSS) and CATIA – Freestyle Sketch Tracer 2 (FSK) particularly in situations where surfacing becomes very complex. It can be used to generate a shape from curves and surfaces, to add details on a model, to sculpt and then copy and paste features from an existing model to another, or to simply work on a polygonal model as obtained from CATIA – Digitised Shape Editor 2 (DSE).

CATIA – Imagine & Shape 2 (IMA)

Dedicated to aesthetical shapes creation for industrial and conceptual design, CATIA – Imagine & Shape introduces very new concepts, breaking the traditional approach of surfaces modeling. It could be used in any domains needing quick surface creation, including rapid virtual prototyping, ideas expression and simulations. Imagine & Shape combines a powerful technology, based on subdivision surfaces, and a simple use, making easy for a non surface specialist to design within a CAD system. Imagine & Shape is really shaped to leverage in V5 the engineering of emotional content: 'From ideas to 3D' becomes then quick and easy for all.

Styled Surface Engineering

CATIA – Quick Surface Reconstruction 2 (QSR)

Quickly recovers surfaces from digitised data that has been cleaned up and tessellated using the CATIA Digitised Shape Editor 2 (DSE) product. Quick Surface Reconstruction offers several approaches to recover surfaces depending of the type of shape: free form fitting, mechanical shape Identifications like plane, cylinder, sphere, cone and primary surface extension. Thanks to QSR's tools which analyse curvature or iso-slope property, users can easily create polygon segmentation in pertinent surfaces area. Quick Surface Reconstruction 2 includes its own quality checking tools.

CATIA – Realistic Shape Optimiser product 2 (RSO)

The new Realistic Shape Optimiser product enables users to capture the actual shape resulting from simulations or based on real-world tests of the product in operation. For instance, tool designers can retrieve from a tooling prototype all the spring-back deformation information needed to create the realistic shape of a stamped part and then optimise the design of the stamping die to accurately fit the specifications.

CATIA – Freestyle Shaper 1 (FS1)

Provides easy to use surface-based tools to help designers create styled shapes, enabling even casual users to easily smooth and trim curves and surfaces. Real-time quality checking is possible through extensive curve and surface diagnosis tools to ensure quality.

CATIA – Freestyle Sketch Tracer 1 (FSK)

Allows the integration of stylists' work (such as 2D painting) into a 3D format, as the basis for 3D virtual mockup. This product provides an intuitive toolbox for helping the user to convert 2D data into 3D data: the user will first position and scale the image in 3D, then use CATIA Freestyle and Generative Shape Design products to draw the geometry over the sketches.



CATIA – Digitised Shape Editor 2 (DSE)

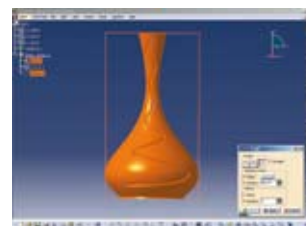

CATIA – Shape Sculptor 2 (DSS)

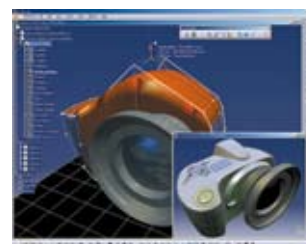

CATIA – Imagine and Shape 2 (IMA)

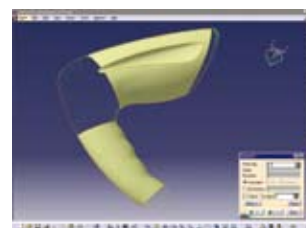

CATIA – Quick Surface Reconstruction 2 (QSR)



CATIA – Freestyle Shaper 1 (FS1)



CATIA – Freestyle Sketch Tracer 1 (FSK)

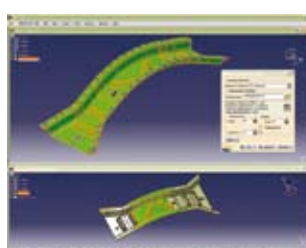

The new CATIA – Realistic Shape Optimiser product (RSO)

Products

CATIA – Freestyle Optimiser 2 (FSO)

Extends the shape and surface modeling functions of CATIA – Freestyle Shaper 2 (FSS) to the morphing of complex, multi-surface shapes. Designers can globally change multiple surfaces as if they were a single patch while preserving the previously prescribed design characteristics. The system is able to match an established design to fit other geometry such as a physical mock-up scan. To verify the quality of surface designs, users can conduct a virtual showroom inspection with real-life cubing visualised by computed reflect lines from a neon row.

CATIA – Freestyle Profiler 2 (FSP)

Addresses intuitive dynamic surface creation by sweeping a profile curve along multiple guides. This product offers associative Styling Sweeps and associative Net Surfaces tools to cover the need for complex profiled surfaces. All types of FreeStyle analysis are provided e.g. curvature analysis, cutting plane, distance analysis, environment mapping and isophotes.

CATIA – Freestyle Shaper 2 (FSS)

Is a P2 product which provides enhanced powerful easy to use surface-based tools. Freestyle Shaper 2 helps designers to create styled shapes and enables even casual users to easily smooth and trim curves and surfaces. Real-time quality checking is possible through extensive industry-oriented curve and surface diagnosis tools to ensure quality.

Mechanical Shape Design

CATIA – Developed Shapes 1 (DL1)

Quickly and easily unfolds ruled surfaces and develops curves on revolution surfaces. Design engineers, both non-surface specialists and advanced-shape designers, can define an associative flattened pattern from their 3D models for manufacturing from flat sheets of raw materials. Developed Shapes 1 features an intuitive cross-platform user interface foster productivity, ease of use, and low training costs.

CATIA – Generative Shape Design 1 (GS1)

Helps design mechanical shapes based on a combination of wireframe and multiple surface features. Generative Shape Design 1 provides an extensive set of tools for creating and modifying mechanical surfaces used in the design of complex shapes or hybrid parts. GS1 brings smart tools, like powercopy to manage the feature reuse. Its feature-based approach offers a productive and intuitive design environment where design methodologies and specifications can be captured and reused.

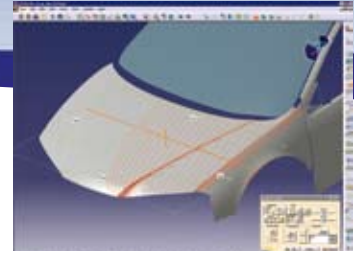

CATIA – Freestyle Optimiser 2 (FSO)

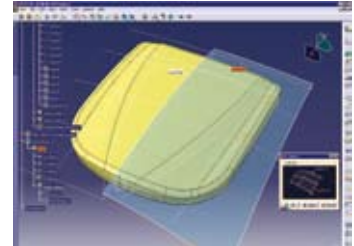

CATIA – Freestyle Profiler 2 (FSP)

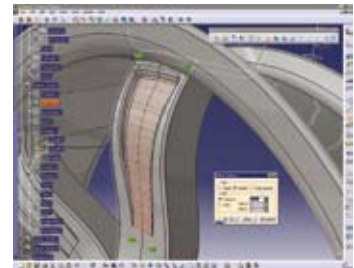

CATIA – Freestyle Shaper 2 (FSS)

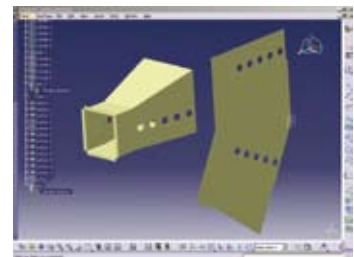

CATIA – Developed Shapes 1 (DL1)



CATIA – Generative Shape Design 1 (GS1)

Products

CATIA – Generative Shape Design 2 (GSD)

Helps to design advanced shapes based on a combination of wireframe and extensive multiple surface features, with full specification capture. Generative Shape Design 2 includes all the functions and commands from the CATIA – Generative Shape Design 1 (GS1) product. It provides an extensive set of tools for creating and modifying mechanical surfaces used in the design of complex shapes or hybrid parts. Its feature-based approach offers a productive and intuitive design environment to capture and reuse design methodologies and specifications.

Knowledgware and laws functionalities included in Generative Shape Design 2 bring to the user the best in class tool to faster create complex surfaces. In addition of Generative Shape Design 2 the CATIA – Generative Shape Optimizer (GSO) product allows access to powerful global deformation technologies.

CATIA – Generative Shape Optimizer 2 (GSO)

Extends the wireframe and multiple surface creation features of CATIA – Generative Shape Design 2 (GSD) with powerful global deformation technologies. Based on exclusive smart tools, Generative Shape Optimizer allows the user to deform shapes quickly and decreases the time to complete the design process.

Surface Assembly

CATIA – Automotive Body-in-White Templates (ABT)

Is an advanced product that uses unique skilled features to boost body in white design phase productivity. These powerful features allow body in white design teams to quickly create or modify a car body in an associative styling and engineering context. For instance, a user can create an associative shape, place welding points on it, and then assemble the two parts with unprecedented rapidity. The manufacturability of the created body is taken into account, as well as the management of potential styling changes. ABT takes advantage of its total integration with the mechanical shape design products, the freestyle products, and the unique CATIA – Automotive Body-in-White Fastening 3 (ABF) product.

CATIA – Automotive Body-In-White Fastening 3 (ABF)

Is dedicated to the design of Automotive Body-in-White Fasteners. It supports Welding technologies and mechanical clinching, along with Adhesives, Sealers, and Mastics.

The user is provided with intuitive tools to create and manage Spot like Fasteners. The user can switch, if needed from a 3D Point shape definition to a 3D hemispherical shape specification. In addition to placing the fasteners, reports can be issued from the application in order to list : Fastener location coordinates and the Joined parts properties at each fastener location.

The CATIA V5 generative feature infrastructure enables the associative update of fasteners feature placements from a part design or assembly structure change.

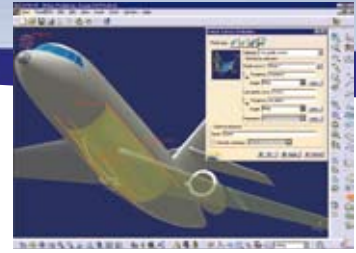

CATIA – Generative Shape Design 2 (GSD)

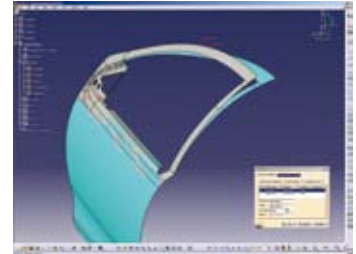

CATIA – Generative Shape Optimizer 2 (GSO)

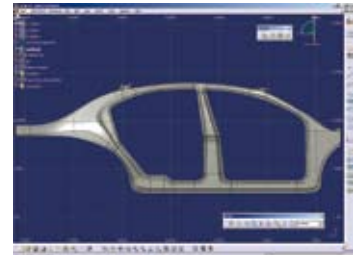

CATIA – Automotive Body-in-White Templates (ABT)

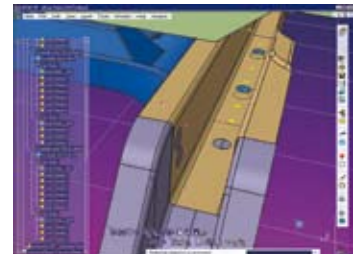

CATIA – Automotive Body-in-White Fastening 3 (ABF)

Products

Rendering

Real Time Rendering (RT1)

Enables designers to leverage technological material specifications to produce realistic renderings of their model. Texture can be created from scratch, modified from imported digital images, or selected from the included library. Associativity is maintained between the material library and the material applied to the parts. Materials can be applied through a specification-driven approach or through simple selection. Real-time display computations quickly convert models to realistic renderings.

Photo Studio 2 (PHS)

Generates high quality photo-realistic images and movies of a digital mock-up, by using a powerful ray-tracing engine. This engine drastically enhances the realism of the resulting images by computing real soft shadows as well as accurate reflections and refractions of light. Photo Studio manages reusable scene settings and delivers powerful animation capabilities. By giving a physically realistic simulation of the model appearance, it can also provide final validation of the design. Photo Studio product is thus able to give a competitive advantage to companies that want to present their products in context to their own customers.

Photo Studio Optimiser 2 (PSO)

Is an essential complement to Photo Studio 2 (PHS) for users who want to create images and movies that will match reality. PSO extends PHS's rendering capabilities with such advanced technologies as global illumination and caustics. With the product's 3D texture and bump mapping capabilities, the user can see at the beginning of its life cycle how the finished product will look.



Real Time Rendering 2 (RTR)

Enables designers to interactively create realistic and dynamic renderings and animations in real-time, by extensively using all the hardware features available. The user can dynamically create and manipulate materials, lights and environments and immediately view the result of any modification. By providing the ultimate dynamic display of the mock-up, Real-time Rendering 2 allows efficient design evaluation and validation at any time during the product development process.



Real Time Rendering (RT1)



Photo Studio 2 (PHS)

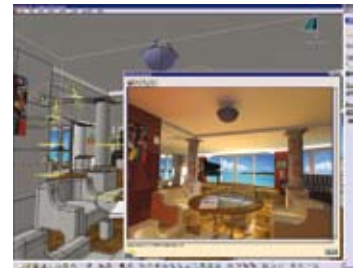

Photo Studio Optimizer 2 (PSO)



Real Time Rendering 2 (RTR)



For more information contact your IBM Marketing Representative, IBM Business Partner, or call one of the numbers below:

AMERICAS

USA (Toll-free) +1 800 395 3339
Canada +1 514 938 6718
Argentina +54 11 4319 6594
Brazil +55 11 3050 5542
Mexico +52 5 270 6426

ASIA / PACIFIC

Australia +61 2 9842 9555
China +86 10 6539 1188 ext. 3454
Hong Kong +852 2825 7614
India +91 20 649 724 / 649621
Indonesia +62 21 523 8622
Japan +81 3 3808 8510
Korea +82 2 3781 6290
Malaysia +60 3 7720 2069
New Zealand +61 2 9842 9555
Philippines +63 2 819 2345
Singapore +65 320 1234
Taiwan +886 2 725 9493
Thailand +66 2 273 4406

EUROPE / MIDDLE EAST / AFRICA

Austria +43 1 211 45 6963
Belgium +32 2 225 2901
CEMA +42 12 4954 1225
Czech Republic +420 2 272 131 742
Denmark +45 4523 3000
Egypt +20 539 2539
Finland +358 9 459 4151
France +33 1 4905 7064
Germany +49 1 805 426 756
Greece +30 1 688 1476
Hungary +36 1 382 5503
Israel +972 3 697 8586
Italy +30 800 753 196
Netherlands +31 20 513 3769
Norway +47 66 99 9361
Poland +48 22 878 6969
Portugal +34 91 397 72 66
Romania +40 0726 222 478
Russia +7 095 940 2000
Slovakia +421 2 4954 1455
Slovenia/Croatia/Serbia/Bosnia and Hercegovina +386 1 479 6676
South Africa +27 860 788 788
Spain +34 91 397 72 66
Sweden +46 8 793 4394
Switzerland +41 58 333 5370
Turkey +90 212 317 1305
United Kingdom +44 870 010 2510

IBM Eurocoordination
Product Lifecycle Management
Tour Descartes
La Defense 5
2, avenue Gambetta
92066 Paris La Defense Cedex
France

The IBM home page can be found at **ibm.com**
IBM, the IBM logo, ibm.com and the On Demand Business logo are trademarks of International Business Machines Corporation in the United States, other countries, or both.

CATIA® is a registered trademark of Dassault Systèmes.

Other company, product and service names may be trademarks, or service marks of others.

References in this publication to IBM products, programs or services do not imply that IBM intends to make these available in all countries in which IBM operates. Any reference to an IBM product, program or service is not intended to imply that only IBM products, programs or services may be used. Any functionally equivalent product, program or service may be used instead.

IBM hardware products are manufactured from new parts, or new and used parts. In some cases, the hardware product may not be new and may have been previously installed. Regardless, IBM warranty terms apply.

This publication is for general guidance only. Information is subject to change without notice. Please contact your local IBM sales office or reseller for latest information on IBM products and services.

Photographs may show design models.

© Copyright IBM Corporation 2005.
All Rights Reserved.

ibm.com/solutions/plm

